



**Asian Electron Co., Ltd.**

Importør

**Extron AS**

Nedre Rælingsvei 261

2008 Fjerdingby

Tlf. 63 83 33 90, Mobil 90032394

[www.extron.no](http://www.extron.no), e-post: [post@extron.no](mailto:post@extron.no)



**1U 19"/>" data-bbox="184 544 838 578"/>**

**1U1KVA & 1U2KVA Series  
Pure Sine Wave Inverter**

**YK-PSW241KVAE; YK-PSW242KVAE**

**YK-PSW481KVAE; YK-PSW482KVAE**

**Instruction Manual**



# List of Contents

<b>1. Features</b>	
1-1 Application	2
1-2 Electrical performance	3
1-3 Mechanical drawings	5
<b>2. Introduction</b>	
2-1 Front panel operations	6
2-2 Rear panel operations	7
2-3 Installation	8
2-4 Quick hook – up and testing	9
2-5 AC safety grounding	10
2-6 Making DC wiring connections	11
2-7 Inverter operation	12
2-8 Cooling fan working code	14
<b>3. Maintenance</b>	14
<b>4. Troubleshooting guide</b>	15
<b>5. Warranty</b>	15
<b>6. Important safety striations</b>	
6-1 General safety precautions	16
6-2 Precautions when working with batteries	16
<b>7. Appendices A</b>	
7-1 220V Dip Switch	17

# 1. Features

- R Load Pure sine wave output (THD < 3%)
- By pass function
- Output frequency: 50 / 60Hz switch
- RS-232 interface / Wire connection to PC
- Wired Remote control (optional)
- Loading controlled cooling fan
- Advanced microprocessor
- Protection: Input Undervoltage  
Input Overvoltage  
Overload  
Short circuit  
Low battery alarm  
Over temperature

## 1-1 Utilities Application

- 1-1-1 Power tools – circular saws, drills, grinders, sanders, buffers, weed and hedge trimmers, air compressors.
- 1-1-2 Office equipment – computers, printers, monitors, facsimile machines, scanner.
- 1-1-3 Household items – vacuum cleaners, fans, fluorescent and incandescent lights, shavers, sewing machines,
- 1-1-4 Kitchen appliances – microwave ovens, refrigerators and freezers, coffee makers, blenders, ice markers, toasters.
- 1-1-5 Industrial equipment – metal halide lamp, high – pressure sodium lamp.
- 1-1-6 Home entertainment electronics – television, VCRs, video games, stereos, musical instruments, satellite equipment.

## 1-2 Electrical Performance

### 1U1KVA

Specification	Model		
Item	YK-PSW121KVAE	YK-PSW241KVAE	YK-PSW481KVAE
Continuous Output Power	850W (1KVA)		
Surge Rating	900W/1Mins , 950W/3Sec , 1000W/1Sec		
Input Voltage	12V	24V	48V
<b>Frequency</b>	<b>50/60Hz ± 0.05% ( Switch Selectable)</b>		
Peak Output Current	9A		
<b>Efficiency (full load)</b>	<b>87%</b>	<b>90%</b>	<b>92%</b>
<b>No Load Current Draw</b>	<b>0.7A</b>	<b>0.35A</b>	<b>0.25A</b>
<b>Output Waveform</b>	<b>R Load Pure Sine Wave &lt;3% THD</b>		
Output Voltage Regulation	200/220/230/240V(Switch Selectable) RMS±3%		
P.F.	0.85		
Input Voltage Range	10-16VDC	20-32VDC	42-62VDC
Protection	Overload, Short Circuit, Reverse Polarity (fuse), Input Undervoltage, Input Overvoltage, Over Temperature		
Digital Display	OVP, UVP, OTP, OLP, VAC, AMP, WATT, VDC, TEMP, Hz		
<b>Safety</b>	<b>EN60950-1</b>		
<b>EMC</b>	EN 55022: 2010/AC: 2011(Class B) EN 55024:2010 EN 61000-3-2:2006+A1:2009+A2:2009 EN 61000-3-3:2013 IEC 61000-4-2:2008 IEC 61000-4-3:2006+A1:2007+A2:2010 IEC 61000-4-4:2012 IEC 61000-4-5:2005 IEC 61000-4-6:2008 IEC 61000-4-8:2009 IEC61000-4-11:2004		
Interface Control Port	RS-232 With Baud Rate 2400,4800, 9600, 19200 (Switch Selectable)		
AC Input	220V AC (180V-260V)		
AC Frequency	(50Hz ~ 60 Hz) ± 3%		
Bypass	4~6ms		
Operating Temperature Range	-20°C to 60°C		
Storage Temperature Range	-30°C to 70°C		
Cooling	Loading controlled cooling fan		
Dimensions	416.8(L) ×424.0(W) ×44.0(H) mm		
Weight	7.5kgs		
The wire gauge for AC input and AC output	#12		
	WARNING: The proper connection needs to be made in reference to line/neutral.		

# 1U2KVA

Specification	Model		
Item	YK-PSW122KVAE	YK-PSW242KVAE	YK-PSW482KVAE
Continuous Output Power	1600W	1700W	1700W
Surge Rating	1870W/1Min, 2040W/20Sec		
Input Voltage	12V	24V	48V
<b>Frequency</b>	<b>50/60Hz ± 0.05% ( Switch Selectable)</b>		
Peak Output Current	11A		
<b>Efficiency (full load)</b>	<b>87%</b>	<b>90%</b>	<b>92%</b>
<b>No Load Current Draw</b>	<b>1.47A</b>	<b>0.8A</b>	<b>0.47A</b>
<b>Output Waveform</b>	<b>R Load Pure Sine Wave &lt;3% THD</b>		
Output Voltage Regulation	200/220/230/240V(Switch Selectable) RMS±3%		
P.F.	0.80	0.85	0.85
Input Voltage Range	10-16VDC	20-32VDC	42-62VDC
Protection	Overload, Short Circuit, Reverse Polarity (fuse), Input Undervoltage, Input Overvoltage, Over Temperature		
Digital Display	OVP, UVP, OTP, OLP, VAC, AMP, WATT, VDC, TEMP, Hz		
<b>Safety</b>	<b>EN60950-1</b>		
<b>EMC</b>	EN 55022: 2010/AC: 2011(Class B) EN 55024:2010 EN 61000-3-2:2006+A1:2009+A2:2009 EN 61000-3-3:2013 IEC 61000-4-2:2008 IEC 61000-4-3:2006+A1:2007+A2:2010 IEC 61000-4-4:2012 IEC 61000-4-5:2005 IEC 61000-4-6:2008 IEC 61000-4-8:2009 IEC61000-4-11:2004		
Interface Control Port	RS-232 With Baud Rate 2400,4800, 9600, 19200 (Switch Selectable)		
AC Input	220V AC (180V-260V)		
AC Frequency	(50Hz ~ 60 Hz) ± 3%		
Bypass	4~6ms		
Operating Temperature Range	-20 °C to 60°C		
Storage Temperature Range	-30°C to 70°C		
Cooling	Loading controlled cooling fan		
Dimensions	416.8(L) ×424.0(W) ×44.0(H) mm		
Weight	9kgs		
The wire gauge for AC input and AC output	#12		
	WARNING: The proper connection needs to be made in reference to line/neutral		

# 1-3 Mechanical Drawings

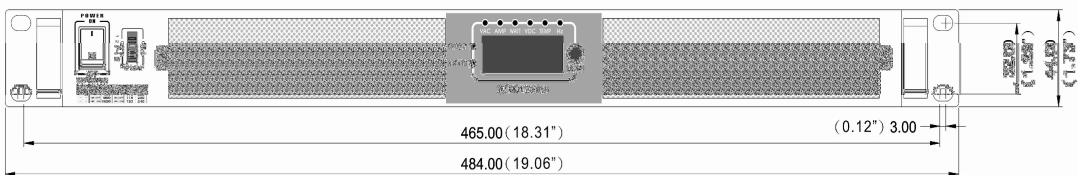
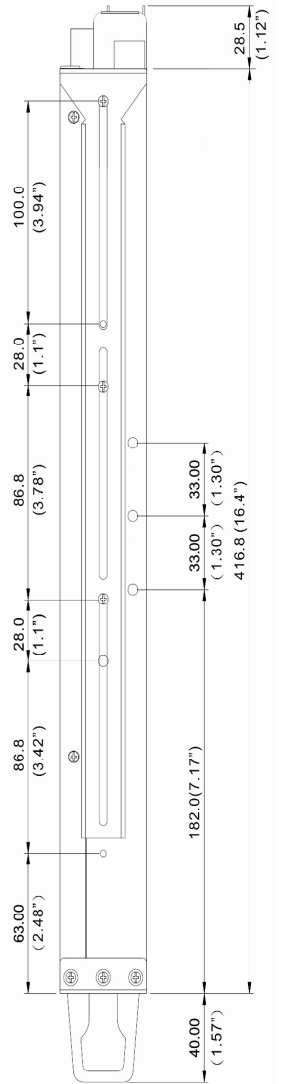
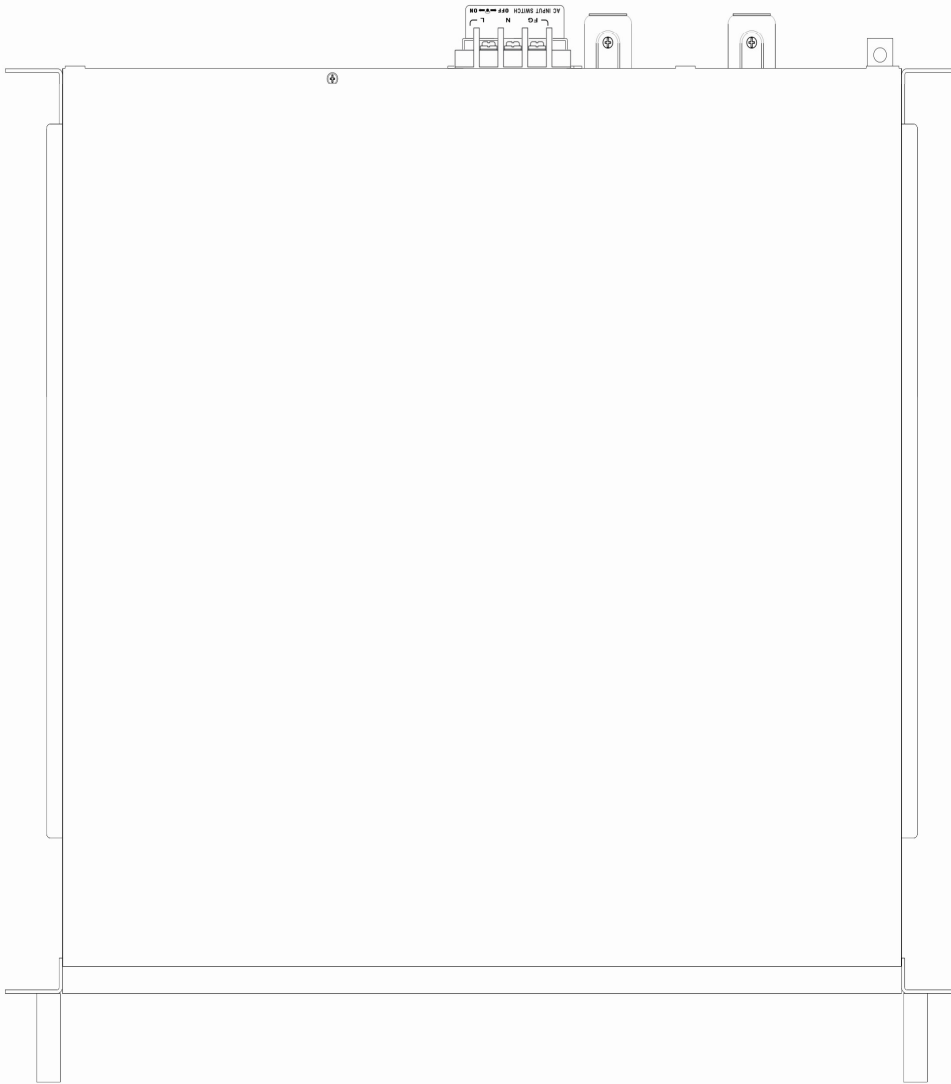
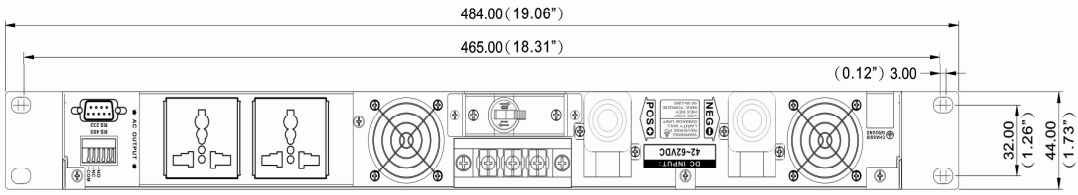

## 2. Introduction:

The power inverter series are the member of the most advanced line of mobile AC power systems available.

To get the most out of the power inverter, it must be installed and used properly. Please read the instructions in this manual before installing and using this model.

### 2-1 Front Panel Operation:

#### 2-1-1 Front view:

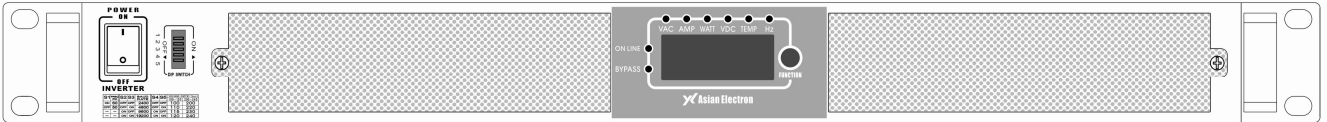

#### 2-1-2 ON / OFF switch:

Please leave in the OFF position during installation.

#### 2-1-3 Function Key

When sequentially push "Function Key", it will display various status on the function screen, Such as VAC, Amp, watts... and so on.

When malfunction is occurred, its display will be flashed on the screen.

#### 2-1-4 AC outlet (Outlet sockets available):

<b>Universal</b>	<b>Australia / New Zealand</b>
<b>North America(GFCI)</b>	<b>North America</b>
<b>AC terminal block</b>	<b>IEC</b>

## 2-2 Rear Panel Operation:

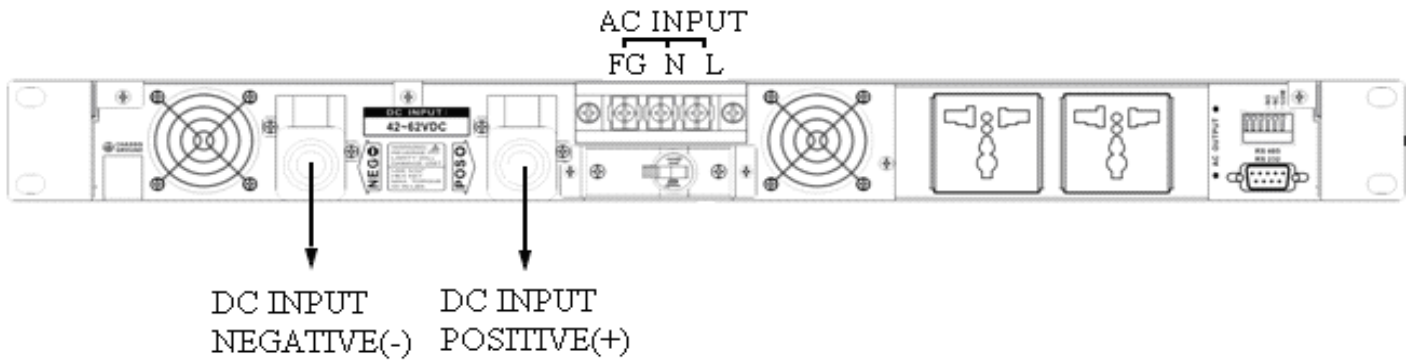

### 2-2-1 Ventilation openings:

Do not obstruct, allow at least 3 inch for air flow.

### 2-2-2 Battery terminals:

Connect to 12V / 24V / 48V battery or other 12V / 24V / 48V power Source.

【 + 】 is positive, 【 - 】 is negative. Reverse polarity connection will blow internal fuse and may damage inverter permanently.



**WARNING!**  
Do not connect the 12V model to a 24V battery. The unit will be destroyed immediately.

### 2-2-3 RS-232:

Connect to computer to remote control working status.

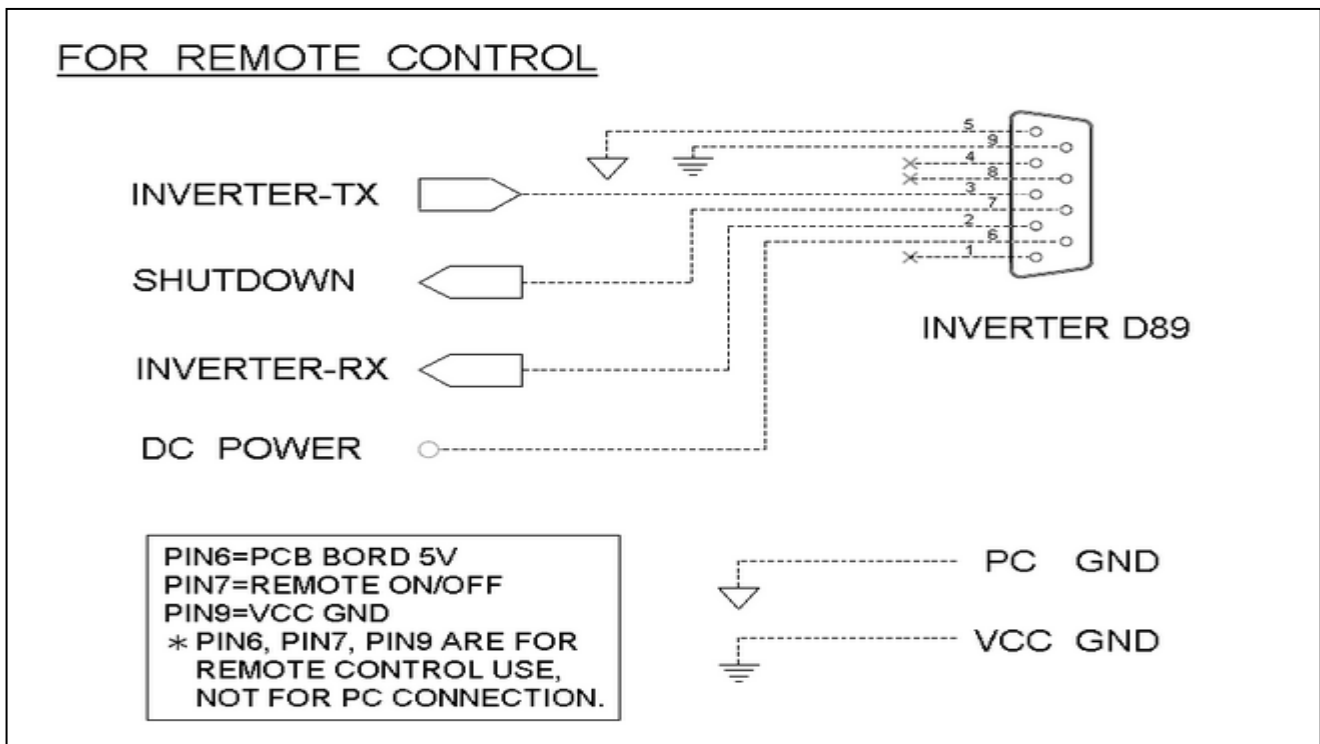



## FOR COMPUTER

PC RS232

INVERTER RS232



### **WARNING!**

Any damages caused by using incorrect RS232 cable will be outside of our warranty scope. If you are not sure which one is correct RS232 cable, please purchase the correct RS232 cable from us directly.

2-2-4 Connect chassis ground terminal to earth or to vehicle chassis using # 8 AWG wire.



### **WARNING!**

Operation of the inverter without a proper ground, connection may result in an electrical safety hazard.



### **WARNING!**

Shock Hazard. Before proceeding further, carefully check the inverter is NOT connected to any batteries, and that all wiring is disconnected from any electrical sources. Do not connect the output terminals of the inverter to an incoming AC source.

## **2-3 Installation:**

Where to install.

The power inverter should be installed in a location that meets the following requirements.

2-3-1 Dry – Do not allow water to drip or splash on the inverter.

2-3-2 Cool – Ambient air temperature should be between -20°C and 50°C, the cooler the better.

2-3-3 Safe – Do not install in a battery compartment or other areas where flammable fumes may exist, such as fuel storage areas or engine compartments.

2-3-4 Ventilated – Allow at least one inch of clearance around the inverter for air flow. Ensure the ventilation openings on the rear and bottom of the unit are not obstructed.

2-3-5 Dust-free – Do not install the Inverter in a dusty environments where are dust, wood particles or other filings/shavings. The dust can be pulled into the unit when the cooling fan is operating.

2-3-6 Close to batteries – Avoid excessive cable lengths but do not install the Inverter in the same compartment as batteries.

Use the recommended wire lengths and sizes (Ref. point 2-6).

Also do not mount the Inverter where it will be exposed to the gases produced by the battery.

These gases are very corrosive and prolonged exposure will damage the Inverter.

## 2-4 Quick hooking – up and testing:

2-4-1 Unpack and inspect the power inverter, check to see that the power switch in the OFF position.

2-4-2 Connect the cables to the power input terminals on the rear panel of power inverter.

The red terminal is positive (+) and black terminal is negative (-).

Insert the cables into the terminals and tighten relative nut to clamp the wires securely.



### **WARNING!**

You may observe a spark when you make this connection since current may flow to charge capacitors in the power inverter. Do not make this connection in the presence of flammable fumes. Explosion or fire may result.



### **WARNING!**

Make sure all the DC connections are tight (torque to 9-10 ft-lbs, 11.7-13Nm). Loose connections will overheat and could result in a potential hazard.

2-4-3 Before proceeding further, carefully check that cable you have just connected negative terminal of inverter to the negative output power source.



### **CAUTION!**

Reverse polarity connection will blow a fuse in inverter and may permanently damage the inverter. Damage caused by reversing polarity connection is not covered by our warranty.

2-4-4 Connect the cable from the negative terminal of the inverter to the negative terminal of the power source. Make a secure connection.



### **WARNING!**

You may observe a spark when you make this connection since current may flow to charge capacitors in the power inverter. Do not make this connection in the presence of flammable fumes. Explosion or fire may result.

2-4-5 Set the power switch to the ON position; you will hear the “bi-bi-bi” sound. At the same time, the display is showed the word “ASIAN” for two times. After that, you will hear the continuous sound from internal alarm. Then, the AC voltage shows on the display. It means the device has done the operation.

2-4-6 Set the power switch to the OFF position; the device shut down completely.

2-4-7 Please use a power meter accurately measure the true output R.M.S. voltage of inverter. We use a power meter such as IDRC CP-350 or ABM 2019 to measure our product.

## **2-5. AC Safety Grounding:**

During the AC wiring installation, Ac input and output ground wires are connected to the inverter. The AC input ground wire must connect to the incoming ground from your AC utility source.

The AC output ground wire should go to the grounding point for your loads ( for example, a distribution panel of bus chassis).

2-5-1 Neutral Grounding (GFCI' s ):

**2-5-1-1 230V models:** There is no connection made inside the Inverter from either the line or neutral conductor to the safety ground.



### **WARNING!**

Do not operate the power inverter without connecting it to Ground. Electrical shock hazard may result.

**CAUTION:** This equipment is designed to permit the connection of the earthed conductor of the DC supply circuit to the earthing conductor at the equipment.

If this connection is made, all of the following conditions must be met:

This equipment shall be connected to directly to the DC supply system earthing electrode conductor or to a bonding jumper from an earthing terminal bar or bus to which the DC supply system earthing electrode conductor is connected.

- This equipment shall be located in the same immediate area (such as, adjacent cabinets) as any other equipment that has a connection between the earthed conductor of the same DC supply circuit and the earthing conductor, and also the point of earthing of the DC system. The DC system shall not be earthed elsewhere.
- The DC supply source is to be located within the same premises as the equipment.

Switching or disconnecting devices shall not be in the earthed circuit conductor between the DC source and the point of connection of the earthing electrode conductor."

## 2-6. Marking DC Wiring Connections:

Follow this procedure to connect the battery cables to the DC input terminals on the Inverter. Your cables should be as short as possible (ideally, less than 10 feet / 3 meters) and large enough to handle the required Current in accordance with the electrical codes or regulations applicable to your installation.

Cables that are not an adequate gauge (too narrow) or are too long will cause decreased inverter performance such as poor surge capability and frequent low input voltage warnings and shutdowns.

These low input voltage warnings are due to DC voltage drop across the cables from the inverter to the batteries.

The longer and narrower these cables, the greater the voltage drop.



### **WARNING!**

The installation of a fuse must be on positive cable. Failure to place a fuse on "+" cables running between the inverter and battery may cause damage to the inverter and will void warranty.

Increasing your DC cable size will help improve the situation.

Our company recommends the following cables for optimum inverter performance.

Model No	Wire AWG	Inline Fuse
YK-PSW121KVAE	#2	150A
YK-PSW241KVAE	#4	80A
YK-PSW481KVAE	#6	40A

Model No	Wire AWG	Inline Fuse
YK-PSW122KVAE	#2/0	250A
YK-PSW242KVAE	#1/0	125A
YK-PSW482KVAE	#2	70A

Also, use only high quality copper wiring and keep cable length short from 3-6 feet.

## 2-7 Inverter Operation:

To operate the power inverter, turn it on using the ON/OFF switch on the front panel. The power inverter is now ready to deliver AC power to your loads.

If you are operating several loads from the power inverter, turn them on separately after the inverter has been turned on.

This will ensure that the power inverter does not have to deliver the starting currents for all the loads at once.

### 2-7-1 Controls and indicators:

The ON / OFF switch turns the control circuit in the power inverter on and off.

The Inverter operates from an input voltage ranging from :

10.0 to 16.0 VDC for 12V models

20.0 to 32.0 VDC for 24V models

42.0 to 62.0 VDC for 48V models

The Inverter will indicate high and low DC voltage conditions as follows:

Model	DC Input over voltage shut-down	DC Input over voltage alarm	DC Input under voltage alarm	DC Input under voltage shut-down
YK-PSW121KVAE YK-PSW122KVAE	16.0VDC	15.5VDV	10.5VDC	10.0VDC
YK-PSW241KVAE YK-PSW242KVAE	32.0VDC	31.0VDC	21.0VDC	20.0VDC
YK-PSW481KVAE YK-PSW482KVAE	62.0VDC	61.0VDC	43.0VDC	42.0VDC

### 2-7-2 Output Voltage Indicator:

LED displays light on VAC as show as output Voltage value

### 2-7-3 Output Current Indicator

LED displays light on AMP as show as output current value

#### 2-7-4 Output Watts Indicator

LED displays light on Watts as show as output Watts value

#### 2-7-5 Input DC Voltage Indicator

LED displays light on VDC as show as input DC voltage value

#### 2-7-6 Temperature Indicator

LED displays light on TEMP as show as internal operating temperature value

#### 2-7-7 Output Frequency AC Indicator

LED displays light on Hz as show as output frequency value

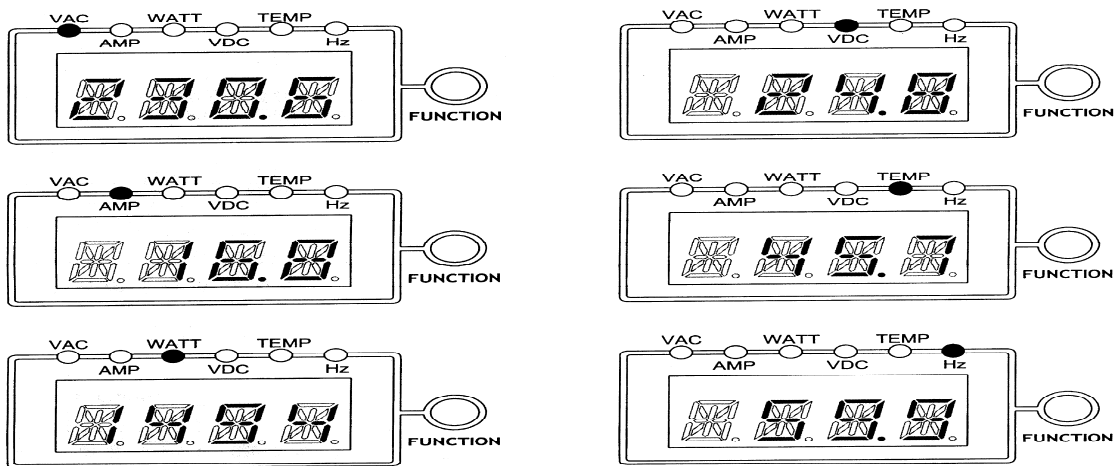

Please have the accuracy of 6 functions of display, as below:

Function	VAC		AMP	WATT	VDC			TEMP	Frequency	
Range	100-120 VAC	200-240 VAC	0-20A	0-2KW	10-16 VDC	20-32 VDC	42-62 VDC	0-50°C	50Hz	60Hz
Accuracy	± 1%	± 1%	1% ± 0.5A	± 3%	± 2%	± 2%	± 2%	± 1%	±0.01	±0.01

#### 2-7-8 Over voltage protection indicator: (OVP)

The over voltage indicator indicates that the power inverter has shut itself down because its input voltage exceeded 12 / 24V / 48VDC version. (Ref. point 2-7-1)

#### 2-7-9 Under voltage protection indicator: (UVP)

The under voltage indicator indicates that the power inverter has shut itself down because its input voltage fell below 12 / 24V / 48VDC. (Ref. point 2-7-1)

#### 2-7-10 Over temp protection indicator: (OTP)

The over temp indicator indicates that the power inverter has shut itself down because its temp has become overheated. The power inverter may overheat because it has been operated at power levels above its rating, or because it has been installed in a location which does not allow it to dissipate heat properly. The power inverter will automatically back up, once it has cooled off.

### 2-7-11 Overload protection indicator: (OLP)

The overload indicator indicates that the power inverter has shut itself down. When output voltage over continue power, then must return to operate manually.

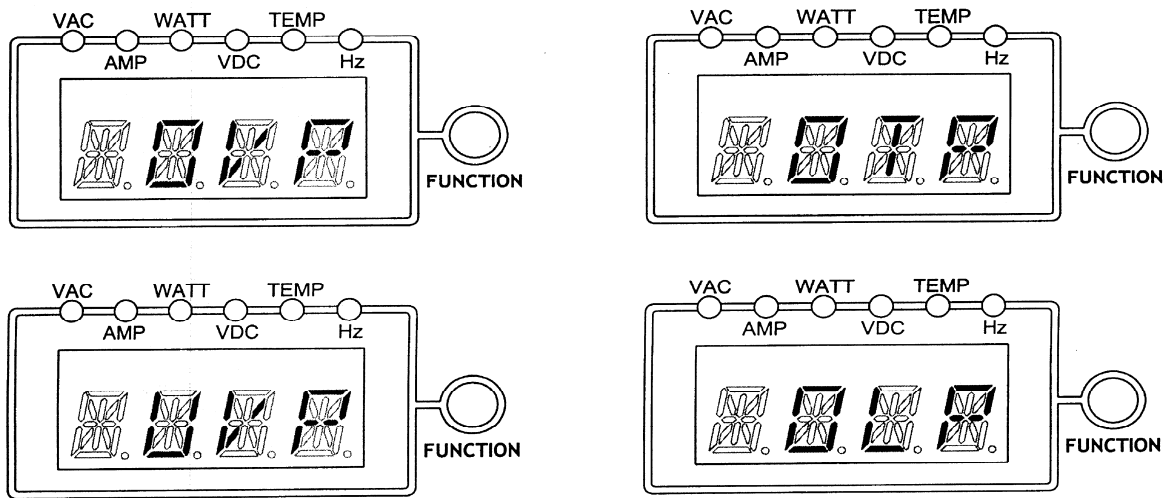

### 2-8 Cooling fan working code:

Cooling fan of inverter is through detecting output power and over temperature situation to work. When start to turn on the inverter and output power is under 300W, the cooling fan does not start running. It complies with saving energy sources requirement. Until, output power is up to 300W, the cooling fan will start to work in order to drop the inner temperature.

If the ventilation opening is obstructed, the inverter will enter over temperature protection mode (OTP). The cooling fan will continue working to drop the inner temperature. When the temperature comes down to normal situation, the inverter will turn on automatically.

## 3. Maintenance:

Very little maintenance is required to keep your inverter operating properly.

You should clean the exterior of the unit periodically with a dry cloth to prevent accumulation of dust and dirt. At the same time, tighten the Screws on the DC input terminals.

## 4. Troubleshooting guide:



### **WARNING!**

Do not open or disassemble the inverter. Attempting to service the unit yourself may result in a risk of electrical shock or fire.

<b>Problem and Symptom</b>	<b>Possible Cause</b>	<b>Solution</b>
Low output voltage (220V: 190-210VAC)	Using average reading voltmeter	Use true RMS reading meter and cable. (Ref. point 2-4-7).
Load display OLP flash	Over load	Reduce load
No output voltage Fault input voltage	Input Undervoltage Input Overvoltage	Recharge battery, check connections and cable. ( Ref. point 2-5 & point 2-6)
No output voltage Over temp indicator Load less than 500W	Thermal shutdown	Improve ventilation. Make sure ventilation openings in inverter are not obstructed. Reduce ambient temperature.
No output voltage Over load indicator	Short circuit or wiring error Very high power load	Check AC wiring for short circuit or improper polarity. (hot and neutral reversed) Remove load.

## 5. Warranty :

We warrant this product against defects in materials and workmanship during warranty period and will repair or replace any defective power inverter when directly returned (postage paid) to us.

This warranty will be considered void if the unit has suffered any obvious damage by natural and man-made factors, or alteration either internal or external and does not cover damage arising from improper use such as plugging the unit into an unsuitable power sources attempts to operate products with excessive power consumption requirement, or use in unsuitable environments.

This is the only warranty that the company makes.

No other warranties express or imply including warranties of merchantability and fitness for a particular purpose.

Repair and replacement are your sole remedies and the company shall not be liable for damages, whether direct, incidental, special or consequential, even though caused by negligence or other fault.



## 6. Important Safety Instructions



### **WARNING!**

Before you install and use your inverter, be to read and save these safety instructions.

### 6-1 General Safety Precautions

6-1-1 Do not expose the Inverter to rain, snow, spray, bilge or dust. To reduce risk of hazard, do not cover or obstruct the ventilation openings. Do not install the Inverter in a zero-clearance compartment. Overheating may result.

6-1-2 To avoid a risk of fire and electronic shock. Make sure that existing wiring is in good electrical condition; and that wire size is not undersized. Do not operate the Inverter with damaged or substandard wiring.

6-1-3 This equipment contains components which can produce arcs or sparks. To prevent fire or explosion do not install in compartments containing batteries or flammable materials or in locations where require ignition protected equipment.  
This includes any space containing gasoline-powered machinery, fuel tanks, or joints, fittings, or other connection between components of the fuel system.

### 6-2 Precautions When Working with Batteries

6-2-1 If battery acid contacts skin or clothing, wash immediately with soap and water. If acid enters eye, immediately flood eye with running cold water for at lease 20minutes and get medical attention immediately.

6-2-2 NEVER smoke or allow a spark or flame in vicinity of battery or engine.

6-2-3 Do not drop a metal tool on the battery. The resulting sparks or short-circuit on the battery or other electrical part may cause an explosion.

6-2-4 Remove personal metal items such as rings, bracelets, necklaces, and watches when working with a lead-acid battery.  
A lead-acid battery produces a short-circuit current high enough to weld a ring or the like to metal, causing a severe burn.

## 7. Appendices A

### 7-1. 220V Dip Switch (at the left side of inverter)

S1	FREQ. (Hz)	S2	S3	BAUD RATE	S4	S5	VOLTAGE OUTPUT (VAC)
ON	60	OFF	OFF	2400	OFF	OFF	200
OFF	50	OFF	ON	4800	OFF	ON	220
----	----	ON	OFF	9600	ON	OFF	230
----	----	ON	ON	19200	ON	ON	240

**S1 ( FREQ. Hz ) – 50Hz/60Hz**

**S2 S3 (BAUD RATE ) – 2400 / 4800 / 9600 / 19200**

**S4 S5 (VOLTAGE OUTPUT ) – 200VAC/220VAC/230VAC/240VAC**

**When you set up S1~S5, please reset the inverter and let update data through CPU.**

#### **RE-MARK:**

**The user manual is subject to change without notice.**

**Produsent:**



**TAIWAN**