

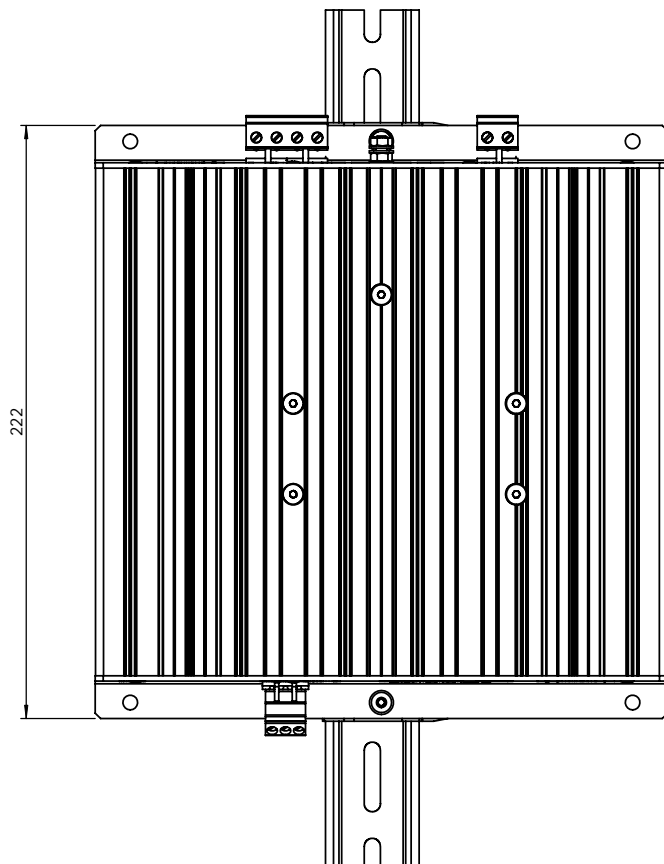

This document is the property of Polyamp AB and shall not, without the permission of Polyamp AB, be allowed, copied, used for manufacturing or communicated to any other person or company.

Weight (kg/m3)	Replaces dwg	Page 1(1)	Associated dwg No.	Units millimeters	Scale 1:2	Rev No. 00
		PM500 Series Standard Wall mounting		Tolerances/Tolerances ISIRI 7161.1 m Rjmmhet/Surf. text RA 6,3		Designer roand Approved by Rev by Date (y/m/d) Date (y/m/d) Date (y/m/d)
Dwg No.						PM500_04

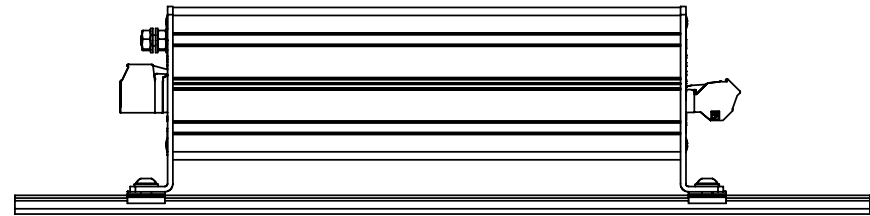
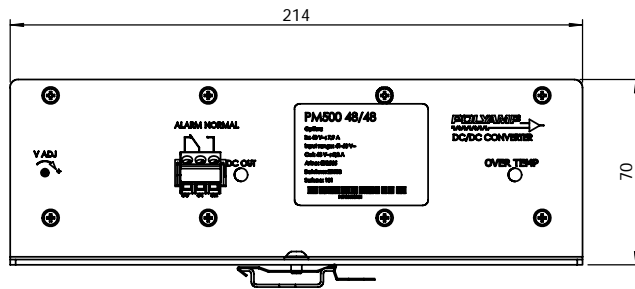

This document is the property of Polyamp AB and shall not, without the permission of Polyamp AB, be allowed, copied, used for manufacturing or communicated to any other person or company.

Weight (kg/m3)	Replaces dwg	Page 1(1)	Associated dwg No	Units millimeters	Scale 1:2	Rev No 00
	PM500 Series Standard DIN rail mounting TS35			Tolerances/Tolerances IS:ISO 2768-1 m Surface/Surf. text RA 6,3	Designer roand Approved by Rev by	Date (y/m/d) 130423 Date (y/m/d) - Date (y/m/d) -
	Dwg No				PM500_08	

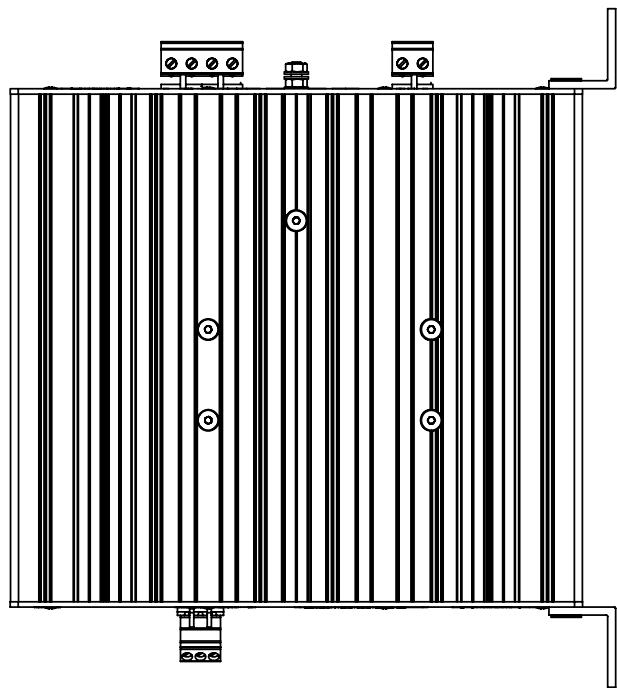
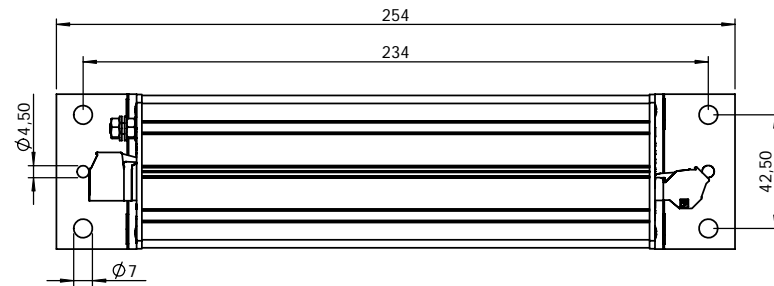
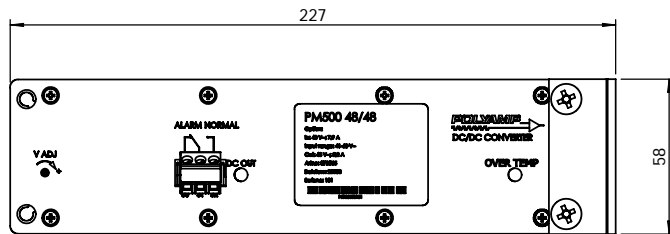

This document is the property of Polyamp AB and shall not, without the permission of Polyamp AB, be allowed, copied, used for manufacturing or communicated to any other person or company.

Weight (kg/m3)	Replaces (dwg)	Page 1(1)	Associated (dwg No)	Units millimeters	Scale 1:2	Rev No 00
		PM500 Series Option 400065 Wall mounting 400065		Tolerances/Tolerances ISIRI 7161.1 m RA 6,3		Designer roand Approved by Rev by Date (y/m/d) Date (y/m/d) Date (y/m/d)
Dwg No.						PM500_02

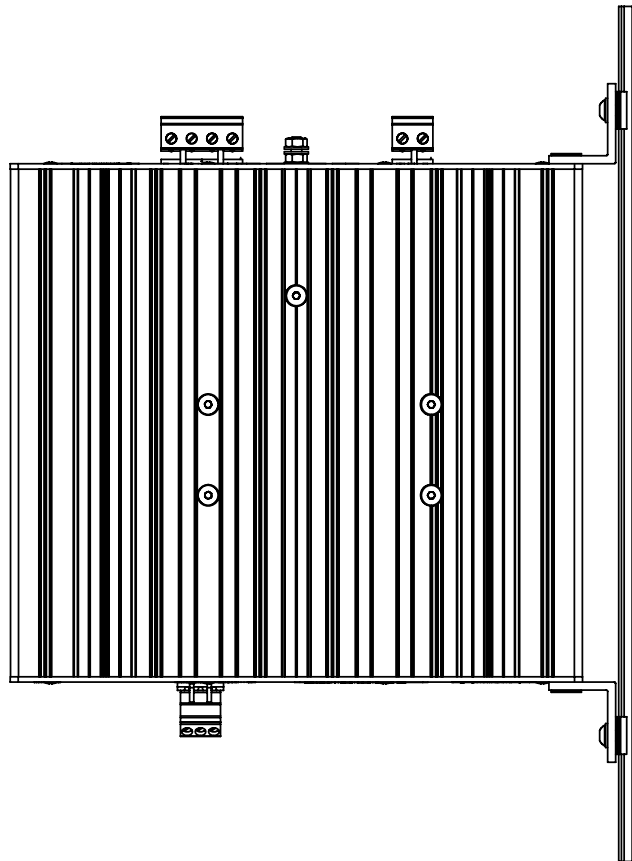
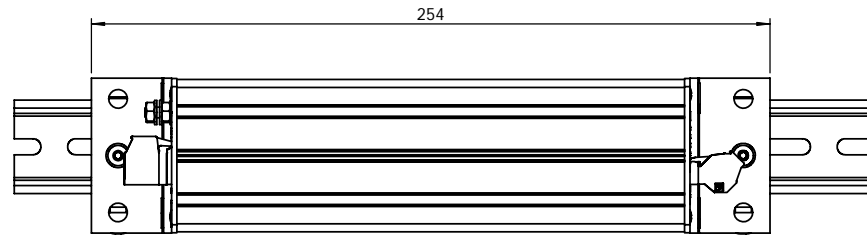
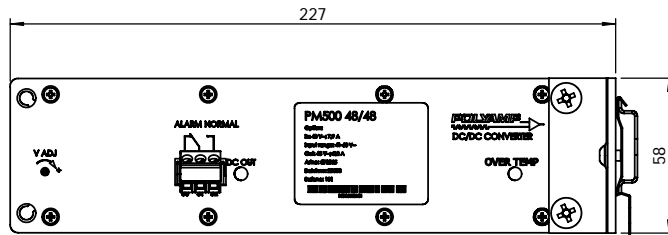

This document is the property of Polyamp AB and shall not, without the permission of Polyamp AB, be allowed, copied, used for manufacturing or communicated to any other person or company.

Weight (kg/m3)	Replaces dwg	Page 1(1)	Associated dwg No	Units millimeters	Scale 1:2	Rev No 00
	PM500 Series Option 400065 DIN rail mounting TS35 400065		Tolerances/Tolerances ISIRI 7161.1 m Rjmmhet/Surf. text RA 6,3		Designer roand Date (y/m/d) 130423	Approved by Date (y/m/d)
			Rev by Date (y/m/d)		Date (y/m/d)	
			Dwg No.		Date (y/m/d)	
					PM500_03	

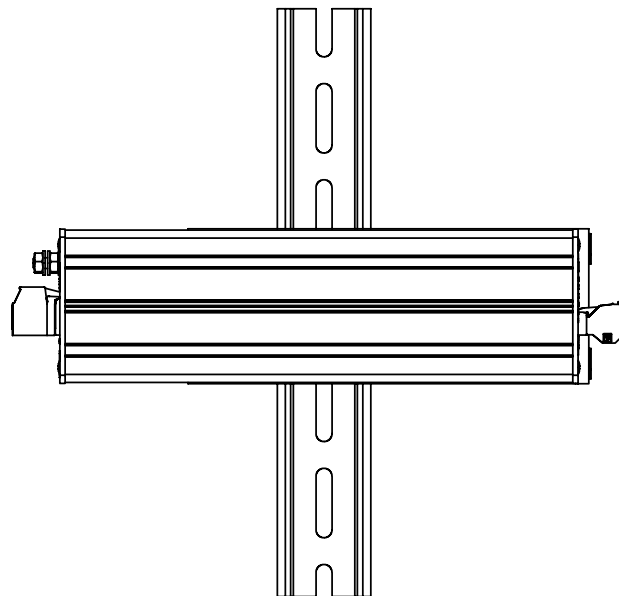
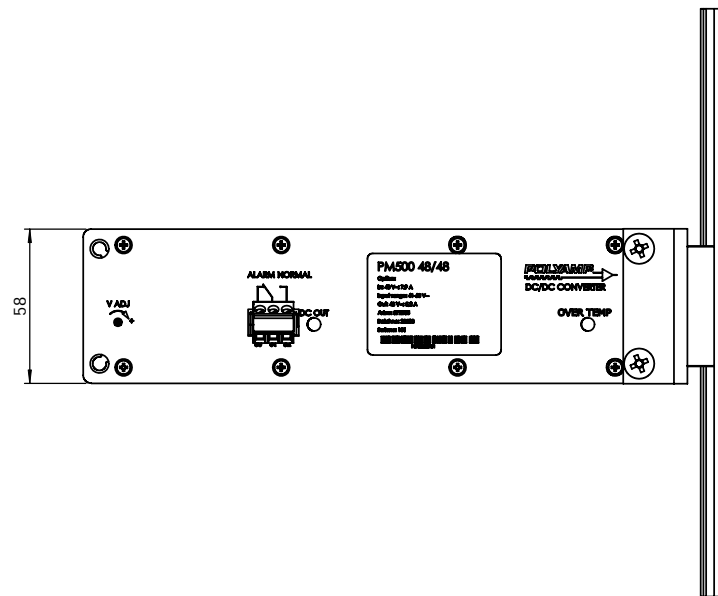
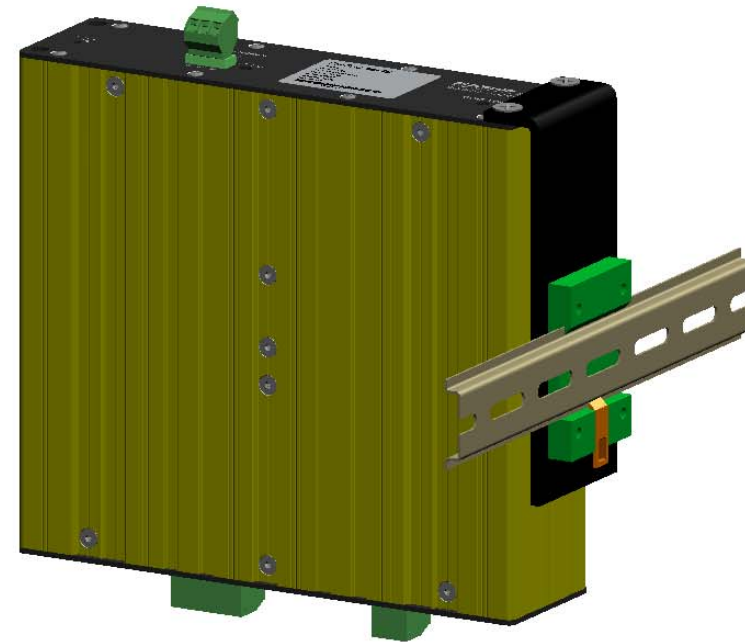
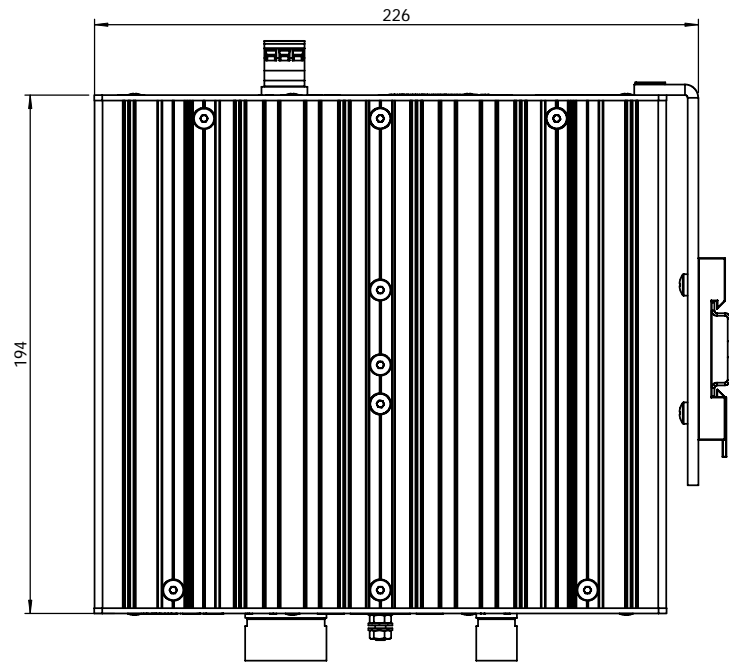

This document is the property of Polyamp AB and shall not, without the permission of Polyamp AB, be allowed, copied, used for manufacturing or communicated to any other person or company.

Weight (kg/m3)	Replaces dwg	Page 1(1)	Associated dwg No.	Units millimeters	Scale 1:2	Rev No 00
	PM500 Series Option 400064 DIN rail mounting TS35 400064		Tolerances/Tolerances IS:ISO 2768:1 m NjmmHes/Surf. text RA 6,3		Designer roand Date (y/m/d) 130423	Approved by Date (y/m/d)
			Rev by Date (y/m/d)		Date (y/m/d)	
			Dwg No.		Date (y/m/d)	
			Date (y/m/d)		Date (y/m/d)	

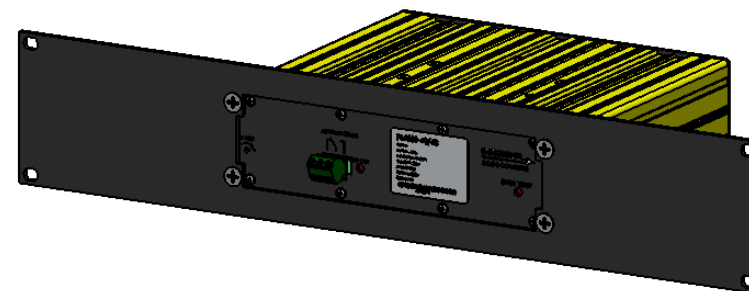
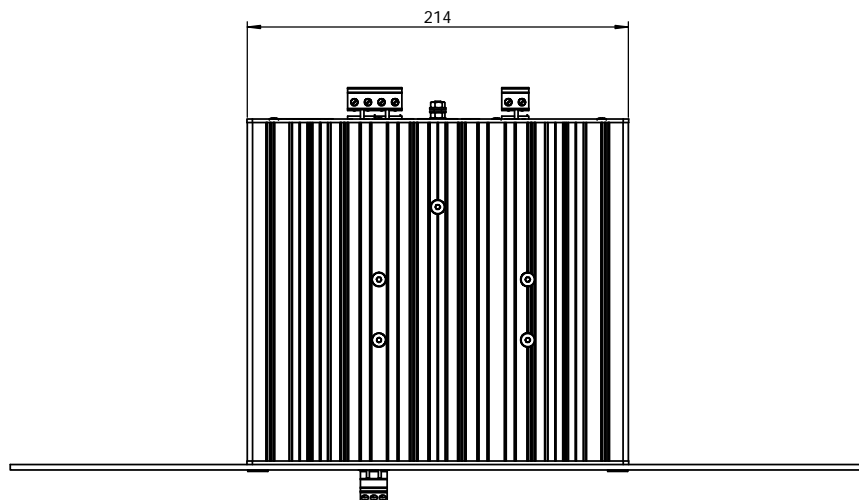
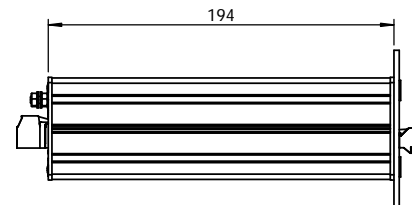
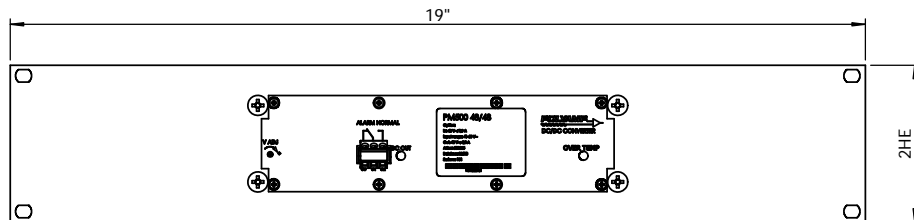

This document is the property of Polyamp AB and shall not, without the permission of Polyamp AB, be allowed, copied, used for manufacturing or communicated to any other person or company.

Weight (kg/m ³)	Replaces (dwg)	Page 1(1)	Associated (dwg No)	Units millimeters	Scale 1:3	Rev No 00	
	PM500 Series Option 400061 19" mounting 1 unit 400061			Tolerances/Tolerances IS:ISO 2768-1 m Surface/Surf. Text RA 6,3	Designer roand Approved by Rev by	Date (y/m/d) 131101 Date (y/m/d) Date (y/m/d)	
	Dwg No					PM500_011	

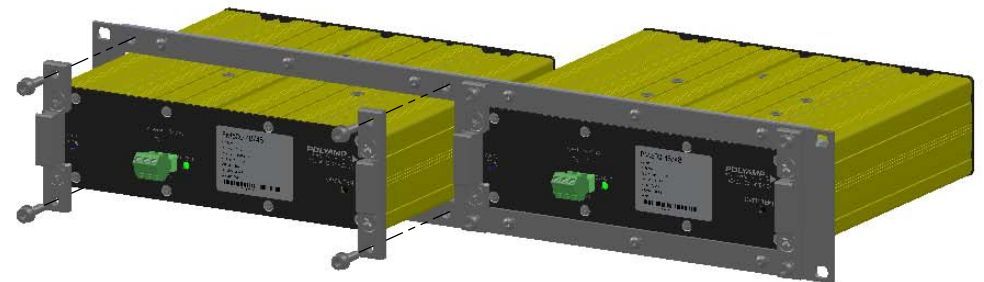
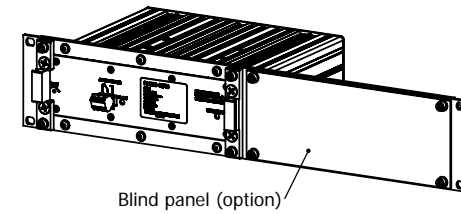
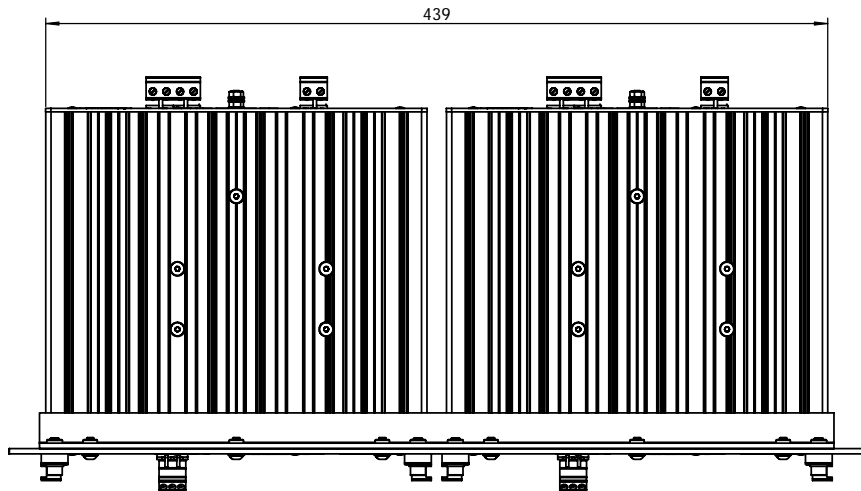
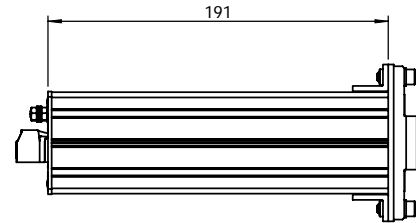
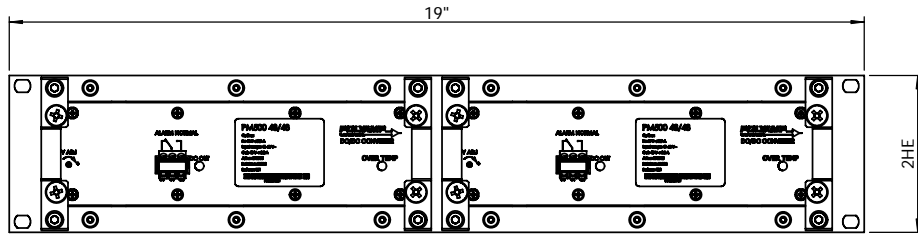

This document is the property of Polyamp AB and shall not, without the permission of Polyamp AB, be allowed, copied, used for manufacturing or communicated to any other person or company.

Weight (kg/m3)	Replaces dwg	Page 1(1)	Associated dwg No.	Units millimeters	Scale 1:3	Rev No 00	
	PM500 Series Option 400062 19" mounting 2 units 400062		Tolerances/Tolerances IS:ISO 2768-1 m Surface/Surf. text RA 6,3	Designer roand Approved by Rev by	Date (yyyy-mm-dd) Date (yyyy-mm-dd) Date (yyyy-mm-dd)	130423 Date (yyyy-mm-dd)	
	Dwg No.					PM500_06	

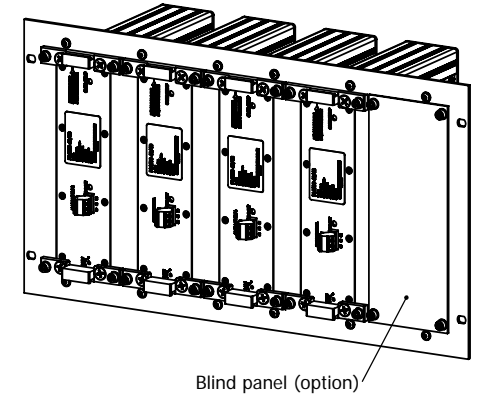
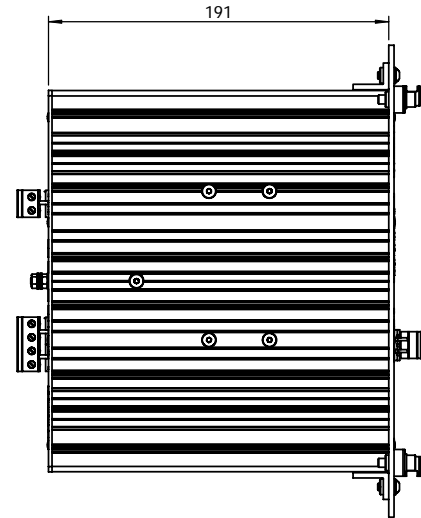
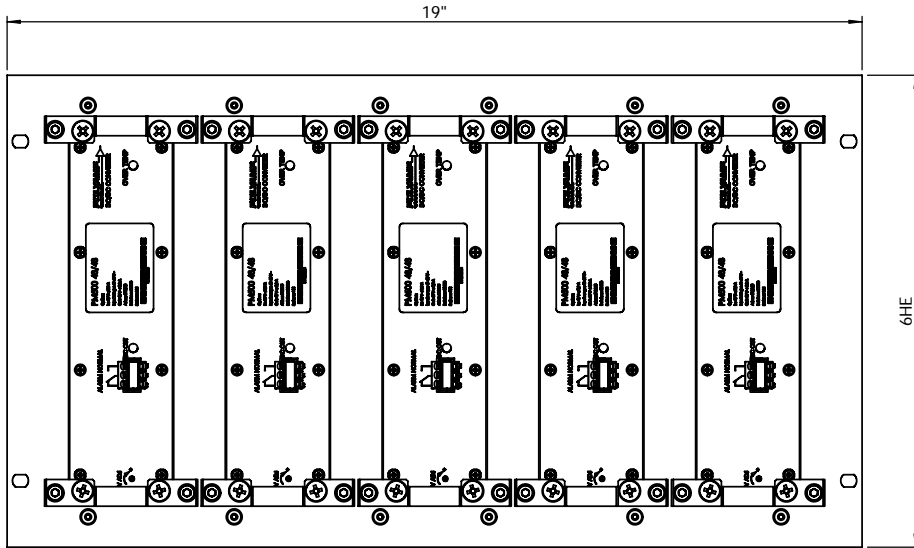

Blind panel (option)

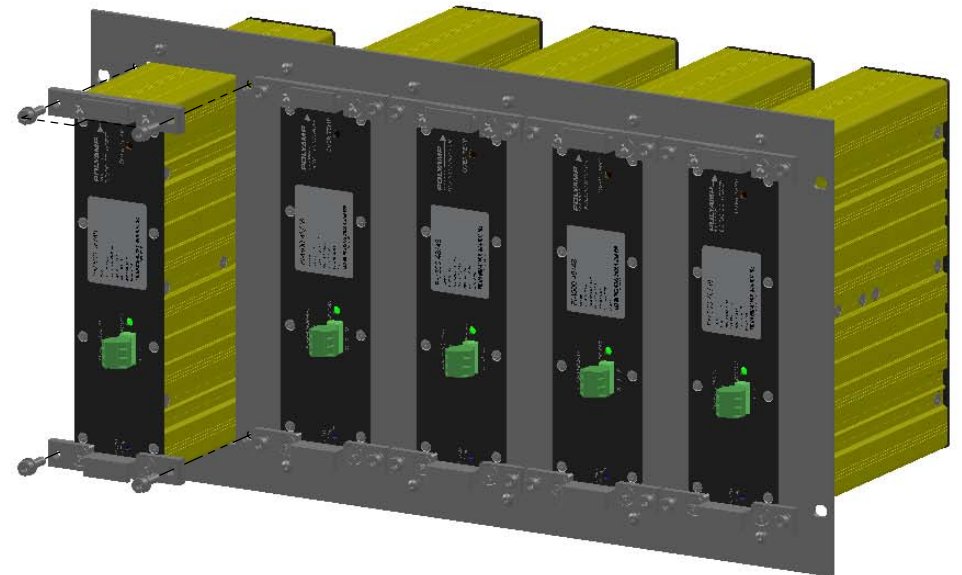
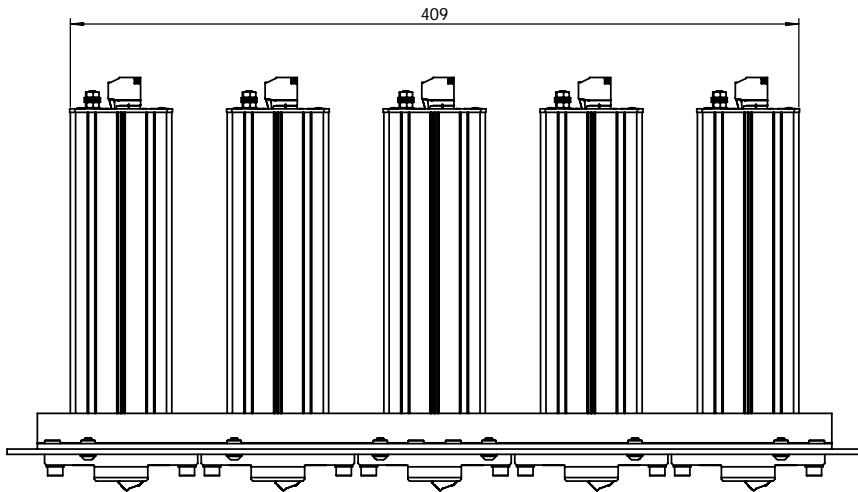

This document is the property of Polyamp. All and shall not, without the permission of Polyamp, be allowed, copied, used for manufacturing or communicated to any other person or company.

Weight (kg/m ³)	Replaces dwg	Page 1(1)	Associated dwg No.	Units millimeters	Scale 1:3	Rev No 00
	PM500 Series Option 400063 19" mounting 5 units 400063		Tolerances/Tolerances ISO 2768-1 Designer round Date (y/m/d) 130423	Approved by RA 6,3 Date (y/m/d)	Rev by Date (y/m/d)	Dwg No. PM500_07

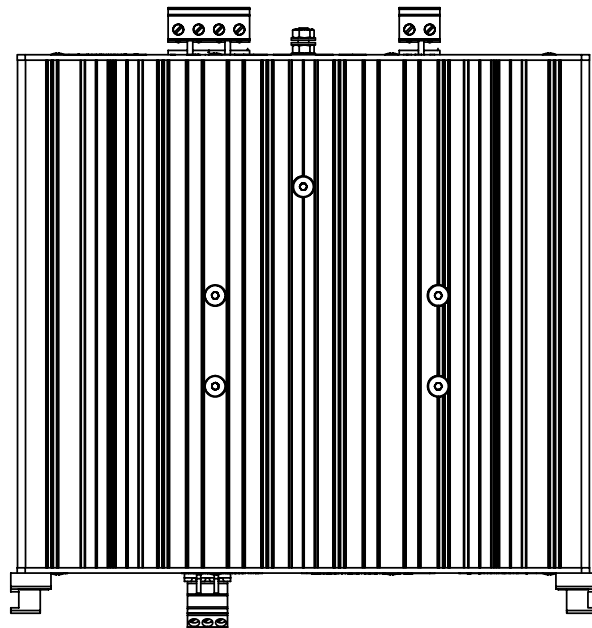
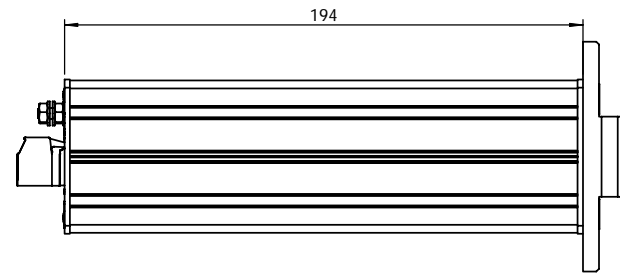
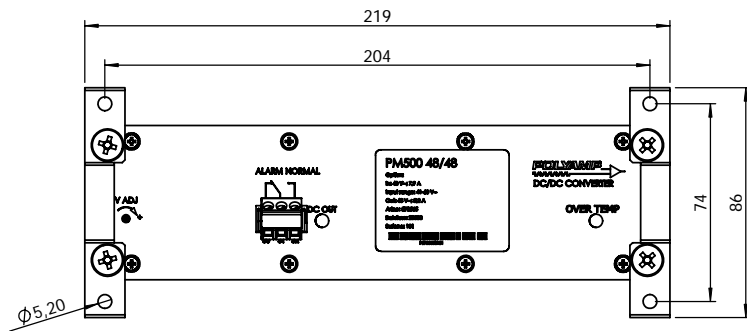

Including
Screw MC6S M5X16 4pcs
Washer BRB M5 4pcs

This document is the property of Polyamp AB and shall not, without the permission of Polyamp AB, be allowed, copied, used for manufacturing or communicated to any other person or company.

Weight (kg/m ³)	Replaces dwg	Page 1(1)	Associated dwg No.	Units millimeters	Scale 1:2	Rev No. 00
	PM500 Series Option 400066 Flat panel with handle 400066		Tolerances/Tolerances ISO 2768-1		Designer roand	Date (y/m/d) 130423
			m		Approved by	Date (y/m/d)
			RA 6,3		Rev by	Date (y/m/d)
			Dwg No.		PM500_09	

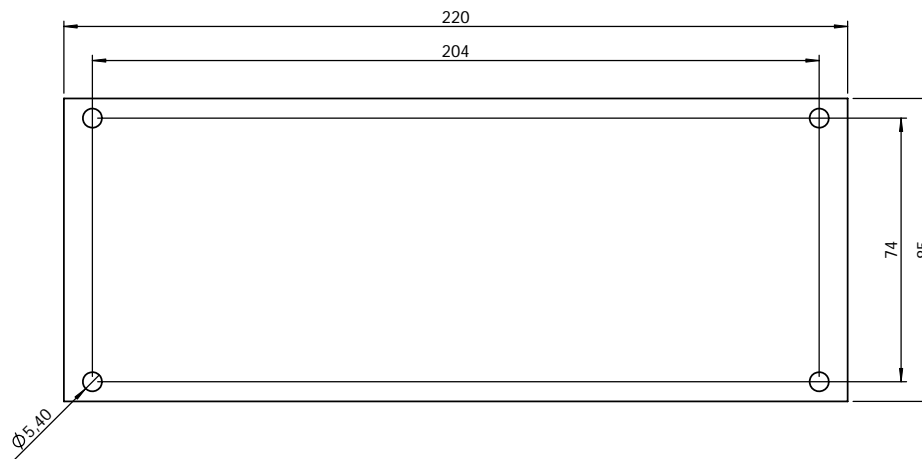

Including
Screw MC6S M5X12 4pcs
Washer BRB M5 4pcs

This document is the property of Polyamp AB and shall not, without the permission of Polyamp AB, be allowed, copied, used for manufacturing or communicated to any other person or company.

Weight (kg/m ²)	Replaces dwg	Page 1(1)	Associated dwg No	Units millimeters	Scale 1:1.5	Rev No 00
	PM500 Series		Option 400067		Tolerances/Intolerances IS:ISO 2768-1 <i>m</i>	Designer roand Date (y/m/d) 130423
	Blind panel		400067		Surface finish RA 6,3	Approved by Date (y/m/d)
					Dwg No.	Rev by Date (y/m/d)
					PM500_010	